

EM-4 F 8 cylinder supplement installation manual. Software version 17.

June 4, 2008

Please read the entire manual before beginning installation.

This system uses two 4 Cylinder SDS coil packs.

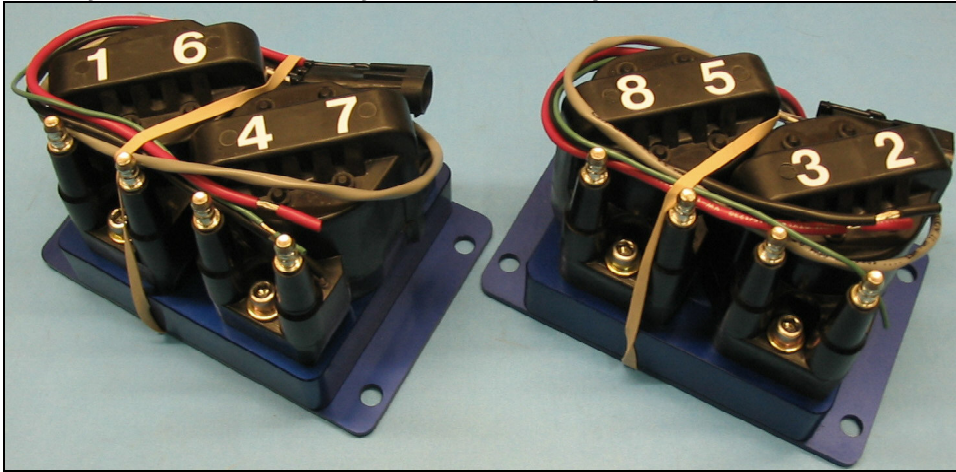

F4PACK.JPG

F6PACK.JPG

Hall sensor

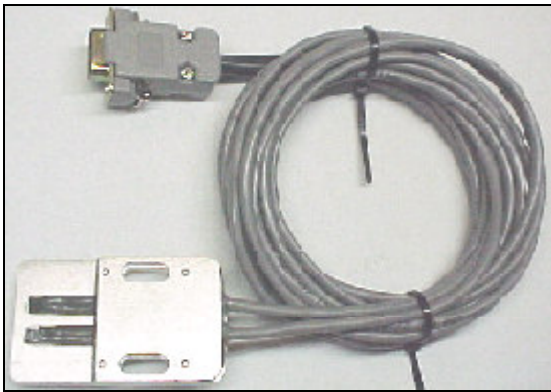

FHALLM.JPG

System Description

The F system is an integrated fuel injection and ignition system. Engine spark timing is fully programmable for both RPM and load (manifold pressure or throttle position). Programming is done with the standard SDS hand-held programmer. Triggering is accomplished with magnets attached to the crankshaft pulley and a Hall effect sensor fitted to the timing cover. As such, timing variations relating to belt and chain deflection or gear harmonics are eliminated.

Theory of Operation

Four Trigger magnets are used on this 8 cylinder system along with one Sync magnet. The Sync magnet is used to synchronize the computer with the engine, so the computer knows which coil to fire. As each magnet passes the Hall sensor, a pulse is sent to the ECU. The ECU determines the exact rpm and manifold pressure, sums the programmed spark retard values and calculates the appropriate delay for the specific conditions at that instant, then triggers each coil to fire at the precise time. Each coil fires two cylinders simultaneously, while one cylinder is on compression, the other on exhaust.

Once the system has been calibrated using a timing light and setting the MAGNET POSITION value with the LCD programmer, then gauge 2 mode will display the actual ignition timing in degrees BTDC in real time. Programming can then be accomplished in the simplest possible terms to understand.

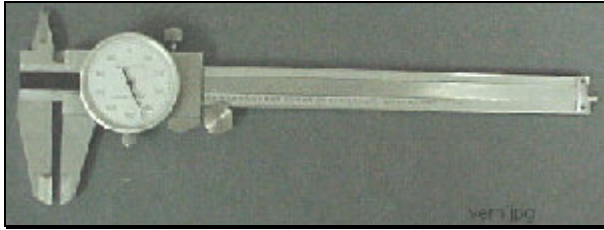
Items required:

Use this end to check hole depth when drilling holes for magnets

Vernier calipers as shown above.

Drill press.
1/8 inch drill bit.
5 minute epoxy.
Tools to remove crank pulley.
Centerpunch.
Use of a lathe is highly recommended.

Magnets

The magnets are very easy to chip, so handle them carefully. They also stick to anything ferrous, making them easy to lose. Magnets also stick together tightly. Separate them with your fingers.

Mounting the Hall Sensor**Some important tips:**

1. You **MUST** decide where the Hall sensor will be mounted before mounting any magnets.
2. This is the most important part of the system installation.
3. Mounting the Hall sensor requires fabricating a very solid bracket that will not vibrate or deflect.
4. Build a mounting bracket that is strong enough to lift the whole engine.
5. The Hall sensor can be mounted anywhere around the pulley that is most convenient, and then the magnets will be positioned relative to where the Hall sensor is mounted.
6. Pulley must be thick enough to drill magnet holes at least .120" or 2.5mm in depth with a 1/8" diameter drill bit.
7. We recommend a minimum clearance between sensor and magnet of 1mm or .040" in the case of solid pulleys and at least 2mm or .080" in the case of rubber damped pulleys.

Try to find a location that will minimize the span of the mounting bracket, so the bracket is shorter and therefore stronger. Look for two bolts on the timing cover that you can span with some thick steel or aluminum. The sensor may be mounted to face either the front or the rear of the pulley depending on where the triggering magnets would be best located and clearance from other interfering items.

Usually mounting the Hall sensor behind the crank pulley is the best place, and will make building a bracket much easier. Mounting the Hall sensor on the front side of the pulley will require longer mounting bolts and a stronger bracket to stop vibration. Also front mounting may make changing the belts difficult.

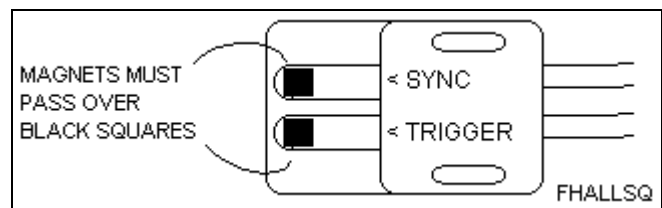

The Hall sensor assembly should be positioned so that the sensor element clears the crankshaft pulley surface by 2 to 4mm or .080" to .160". The square black sensor element must be placed so that the magnets on the crank pulley spin over its center with 1 to 3mm or .040" to .120" clearance. Magnets should protrude about 1 to 1.5 mm or .040" to .060" past the pulley face. The sensor bracket should be initially positioned in the center of its adjustment slot to allow maximum movement in or out for final placement once the magnets are in the pulley. The sensor is supplied with #10-24 Allen bolts.

Slot spacing is 1.100 inch. Use a #25 drill and tap with a #10-24 tap.

The wires leading from the sensor should be securely wire- tied every few inches to avoid vibration breakages.

Crank pulley

Check for TDC marks on the pulley and timing cover. It is best to remove the #1 spark plug, and insert a piece of welding rod into the cylinder, and then verify that the TDC marks are actually correct on the pulley and timing cover. In some cases, the pulley may have been changed on the engine, and could have come from a different model year, so the timing marks could be wrong.

If the pulley has no marks for TDC, then put the #1 piston to TDC, and make your own marks on the timing cover and pulley. It's a good idea to paint the pulley timing marks with some white paint or correction fluid(white-out), so that they are easy to see with a timing light.

If the engine is not at TDC #1 when marking the pulley for magnet placement, the magnets will be in the wrong position and the engine will not run.

Locating the position of the #1 Trigger magnet

You should first know the direction of rotation of the engine when it is running. Most engines rotate clockwise when running, although some such as front-drive Honda rotate counter-clockwise.

Rotate the crankshaft to TDC #1 and leave it there.

Draw an arrow on the pulley to indicate direction of rotation.

The #1 Trigger magnet should be positioned approximately 80 degrees from the Hall sensor, in the direction of the arrow. You must mark the pulley at this location. In this example the #1 magnet location is approximately in the five o'clock position. You do not need to be perfectly accurate here, so anywhere from 75 to 85 degrees is acceptable. You can use the 80 degree cardboard template to help locate the position of the #1 magnet.



In this example, the engine rotates clockwise as shown by the arrow marked on the pulley. If this engine happened to rotate counter-clockwise, like a front-drive Honda, then the #1 magnet mark would be at roughly the one-o'clock position on this particular engine shown.

In this photo the crank is at TDC #1.

1MAGNET.JPG

The pulley can now be removed.

Using a marking pen, draw the #1 magnet mark through the belt groove around to the back side of the pulley. In this installation the magnet will be in the back side.

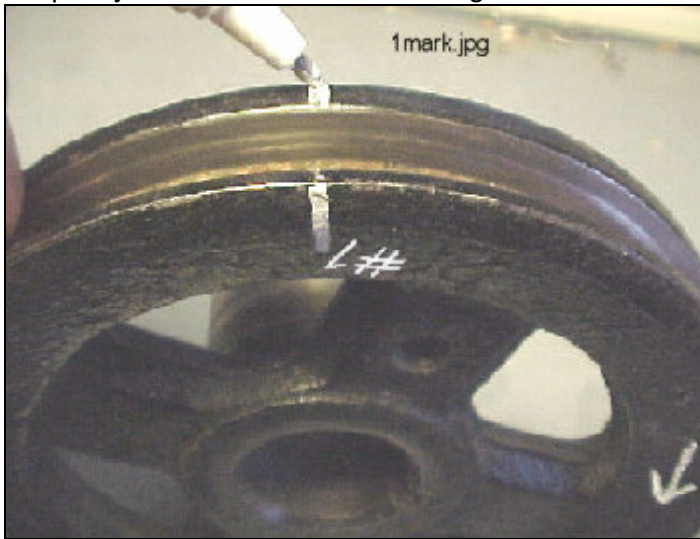

Locating the position of the Sync magnet

The location of the Sync magnet is 40 degrees from the #1 magnet mark in the direction of the arrow drawn on the pulley. Use the cardboard template and mark the pulley.

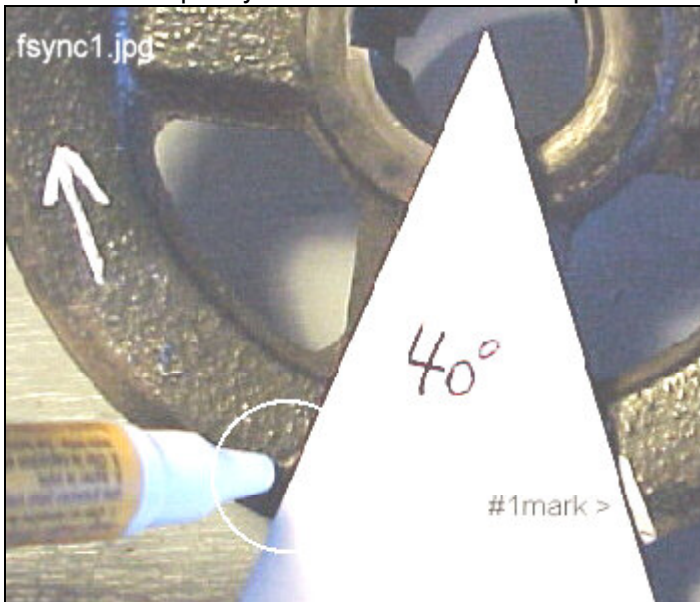

Using a marking pen, draw the Sync magnet mark through the belt groove around to the back side of the pulley. In this installation the magnet will be in the back side.



Lightly scribe a groove around the pulley with a lathe on the surface of the pulley where the magnets

will be mounted. In this case on the back side of pulley.

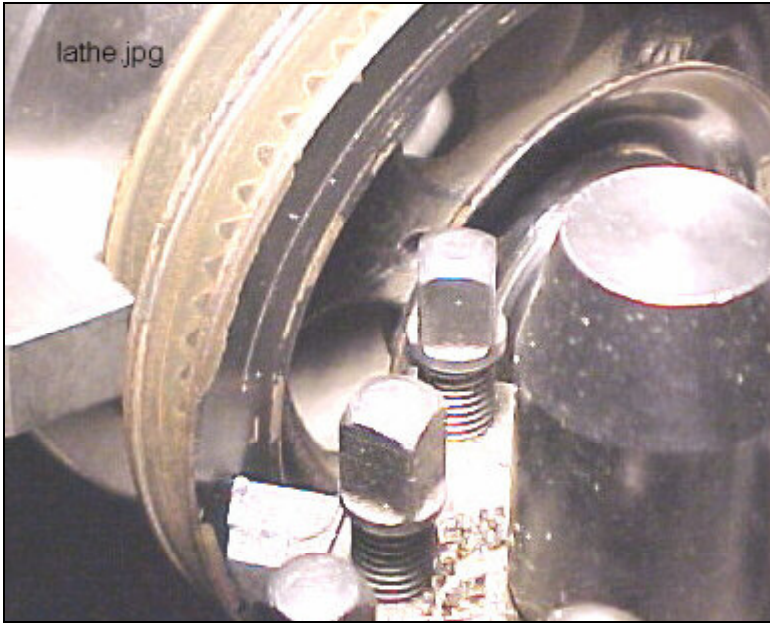

Pulley in the lathe. We recommend that you don't run the lathe motor, just rotate the chuck by hand slowly, with only light pressure on the cutting tool.

Centerpunch the pulley where the #1 mark crosses the scribed line in the pulley. This punch mark will **later** be drilled for the #1 Trigger magnet. Also centerpunch the pulley where the sync mark crosses the scribed line in the pulley. This punch mark will later be drilled for the Sync magnet.

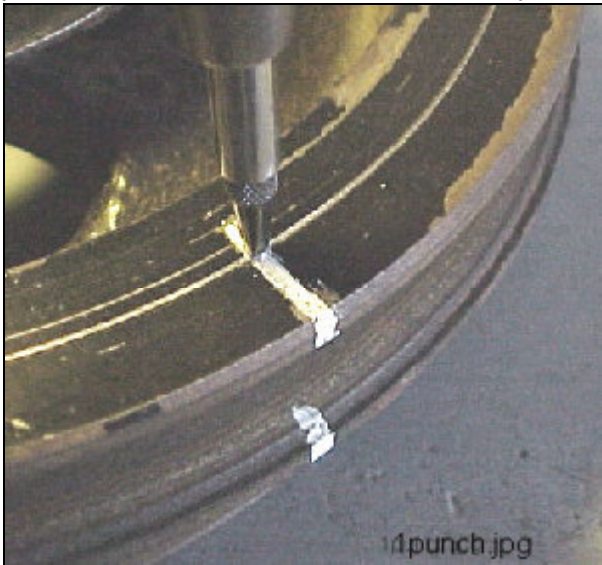

Using dial calipers, precisely measure the diameter of the scribed circle. Write down this measurement for later.

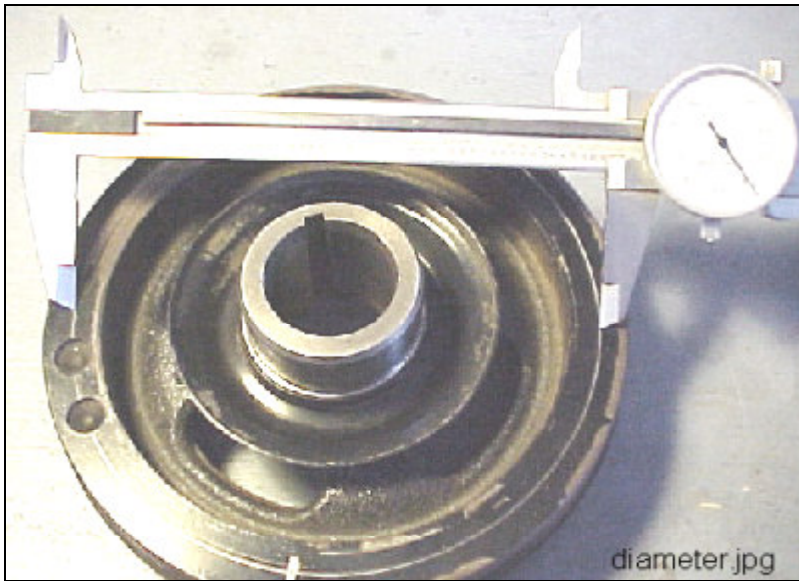

Locations of remaining trigger magnets

On 8 cylinder engines three more Trigger magnets are used, 90, 180 and 270 degrees from the #1 Trigger magnet location.

The diameter of the lathe scribed circle divided by 1.414 will give the dimension of 4 equidistant points along this scribed line when using calipers or dividers.

Example:

The pulley below has a scribed diameter of 5.340 inches. 5.340 divided by 1.414 equals 3.776 inches. In the photos the calipers are spread to 3.776, so in two steps we can locate the position of the second magnet. Do this step carefully and be as accurate as possible.

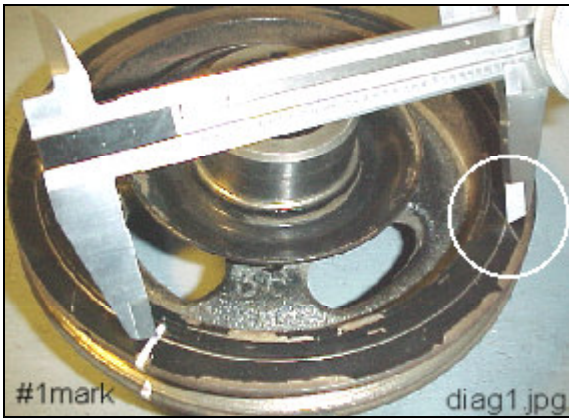

Scribe an arc with the calipers and center punch this arc where it crosses the scribed line.

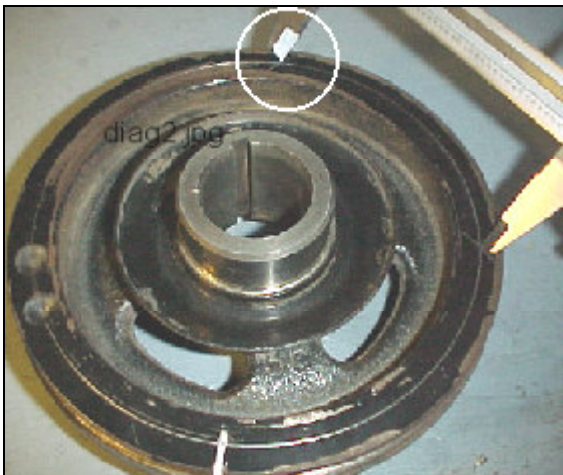

Scribe another arc at the top. This point is 180 degrees from the #1 Trigger magnet mark on the pulley. This point can be center punched for drilling.

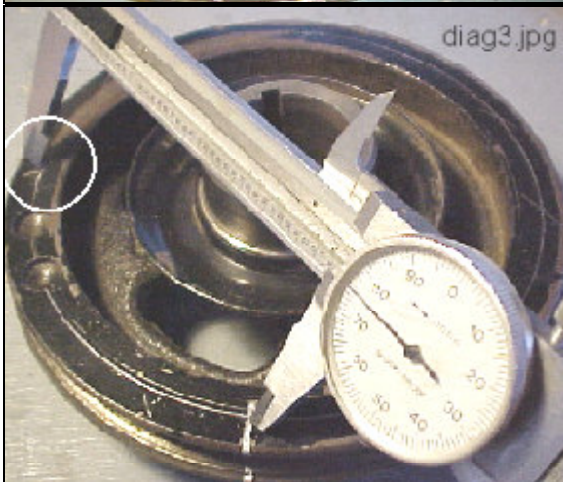

Scribe the last point with calipers and center punch this location for drilling.

See drilling holes for magnets section.

Schematic top view of hall sensor, pulley and bracket.

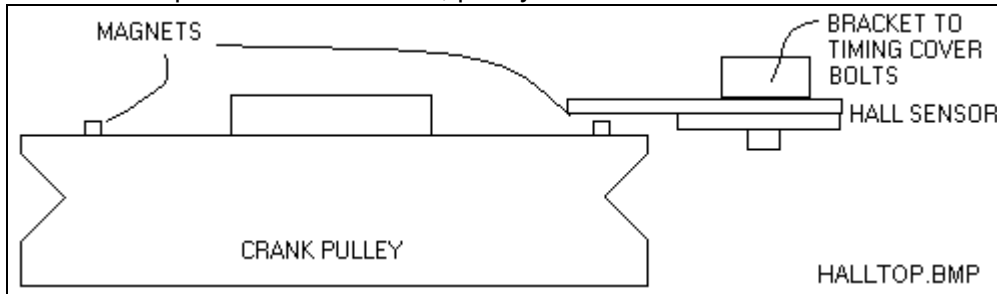

End view of magnet locations relative to the sensor.

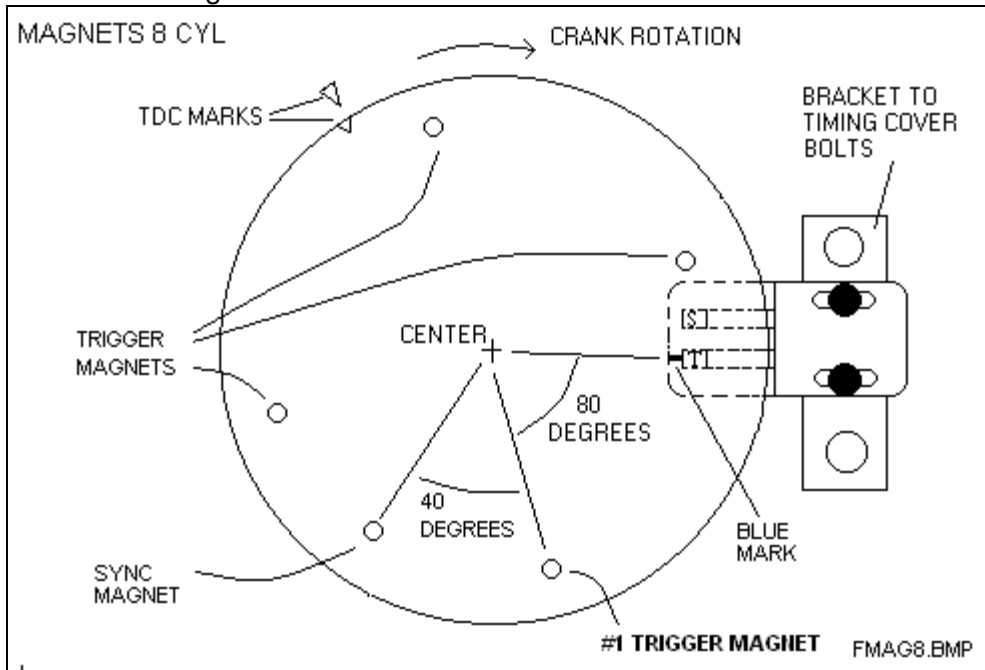

Drilling holes for magnets

Drilled holes should all be the same depth, so drill slowly and measure depth carefully. Magnet holes are best drilled with a #30 drill bit which is 0.1285" diameter. A 1/8" bit may also be used but can be a sometimes too tight, making the magnet & epoxy difficult to fit into the hole, due to hydraulic effect. Often times the magnets will spring up out of the hole, so it's a good idea to have a heavy object to place over the magnets to hold them down in the holes until the epoxy glue has dried.

The magnets are 4.7mm or .187" long. Depth of the hole should allow the top of the magnet to sit about 1.5mm or .060" above the surface of the pulley, so hole depth should be about 3 to 3.5mm or .120" to .135" deep. Drill carefully and check the depth of the hole with the end of the calipers.

If the magnets need to be flush with the pulley surface, then air gap to the Hall sensor will need to be reduced because of a weaker magnetic field. This will make Hall sensor alignment more difficult. Flush mounting is not recommended unless the pulley is aluminum.

Gluing magnets

IMPORTANT!

Trigger magnets go into the holes with the BLUE end visible, facing the hall sensor. The Sync magnet goes into the hole with the BLUE end inside the pulley, facing away from the hall sensor.

Insert a magnet into the hole without epoxy first to see if it will fit. If not, drill holes with #30 drill bit. Do not use a hydraulic press or hammer to push in the magnets. This will break the magnets.



Holes should be clean and dry. Mix some 5 minute epoxy, then fill each hole with epoxy, then push the magnets into the holes. Have a heavy object you can place over top of the magnets to hold them down until the epoxy dries.

The pulley and Hall sensor can now be installed on the engine. **Make sure the pulley will rotate without touching the magnets.** Air gap from magnets to the sensor should be about 2 to 3mm or .080" to .120". Magnets must pass over the small black square in the Hall sensor, so this can be adjusted by loosening the mounting bolts then sliding the sensor until the black square is across from one of the magnets.

Coil pack mounting and care

1. **Do not mount the coil pack to the engine. Vibration from the engine may cause the coil pack to fail.**
2. Mount the coil pack at least 12 inches(30cm) from hot exhaust components. Build a heat shield if necessary to reflect heat.
3. Try to mount the coil pack with the wires facing down. This helps prevent water from entering the coil pack through the wiring grommets. You may want to add some silicone around the wires where they exit the coil pack to help prevent water from leaking into the coil pack. Avoid spraying the coil pack with a pressure washer. Electric motor spray cleaner can be used to clean the coil pack if necessary.

Wiring connections

Hall sensor plugs into the EM-4 as show here:

Inj drive main harness **Hall** programmer



ECUPLUGS.JPG

Coil pack:

Red to +12V **key switched circuit with 7 ½ Amp fuse**. Leave this wire unconnected until you have the hall sensor installed and all magnets are aligned and being seen for 2 to 3 degrees of crank rotation.

The best place to connect this wire is to the original power wire for the factory ignition circuit. The fuse could save the coil pack from damage caused by incorrectly installed magnets and hall sensor.

Always disconnect this wire when rotating the crankshaft to check Hall sensor and magnet alignment.

Black to Ground.

Green to tachometer.

Black 2 conductor plug to main harness.

Tachometer signal options

Factory tach

If using a factory 8 cylinder tach, it might operate using the pin12 main harness 5 volt tach signal. This signal requires you to solder a wire onto pin12 of the main harness connector.

Afermarket tach

The tachometer signal frequency from the coil pack green wire is equivalent to a 4cyl signal. So if an aftermarket tach is connected here then set it for 4cyl operation. Only connect your tach's signal wire to one of the coil pack green wires. The 2nd coil pack green wire should be left unconnected.

A factory 8 cylinder tach cannot be connected to the coil packs green wire because the frequency will be half so the reading would be half.

Do not connect the two coil pack green wires together. This may work however once the engine rpms are higher, ignition signals will overlap and cancel out causing the tach will drop to zero.

Spark plug wire connections to coil packs

Coil pack firing order occurs in this order:

Coil pack #1 left coil first, then coil pack #2 left coil, then coil pack #1 right coil, finally coil pack #2 right coil. In other words signals alternate from one coil pack to the other.

| Coil pack # | Most | LS | Ford |
|-------------|------|-----|------|
| 1 | 1-6 | 1-6 | 1-6 |
| 2 | 8-5 | 8-5 | 3-5 |
| 1 | 4-7 | 7-4 | 7-4 |
| 2 | 3-2 | 2-3 | 2-8 |

Most=AMC, Buick, Chev, Dodge, Pontiac, Olds, Lexus. LS= Corvette/Cadillac engines. Ford =5.0, 4.6 351W, 351M, 351C, 400

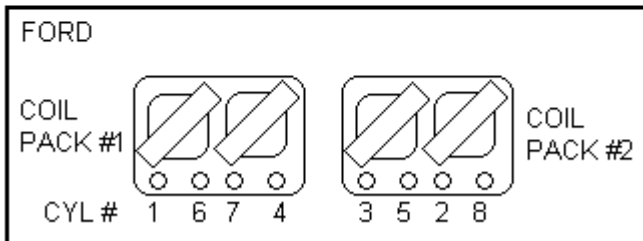
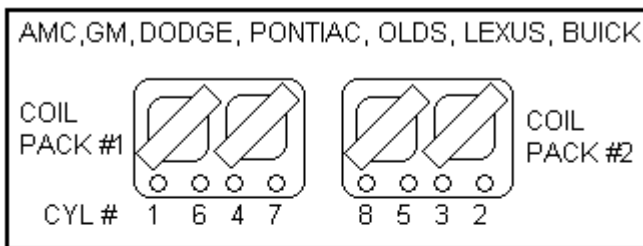

Technical notes:

Even though the Chev LS has a different firing order, the numbering of coil packs is the same as other V8 engines, this due to the waste spark arrangement. Spark plugs fire on compression and exhaust.

Optional Knock Sensor hookup & mounting



GM sensor
KNOCKGM.JPG

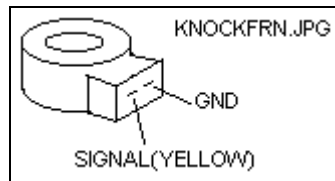

Pinout of most Japanese and German

built sensors.

Hookup:

SDS supplied sensor is the GM type which plugs into the yellow wire.

Most Japanese 1 and 2 wire sensors will work with the EM-4.

German made 2 terminal sensors will work with the EM-4. The 3 terminal German sensor is not recommended due to too low voltage output.

If Japanese or German 2 wire sensors are used, they must connect to the yellow wire and they also have a ground terminal which should be run together with the yellow wire and grounded at the same place as the EM-4 24" ground wire.

Mounting:

The sensor should be mounted in the block, within 2 inches of the top, close to the cylinders. It should never be mounted close to any obvious noise generating components such as a fuel pump or camshaft lifters. In most cases, mounting it in the head is also a poor choice because of valvetrain noise. A thick area of the block with a boss is the best place to drill a (13mm) .500 inch hole. The hole should be (13 to 16mm).500 to .625 inches deep. Make absolutely sure that it is safe to drill a hole of this dimension where you plan to!

The hole should be tapped with a 9/16 UNF starter tap. Depending on the tap, you should only go in 4 turns to begin with, clean out the chips and try the sensor for fit. Keep tapping one turn at a time until the sensor threads in 4 to 5 turns with hand pressure. Stop tapping when the sensor will screw into the hole 6 to 7 threads with a wrench. Note that the thread on the knock sensor is a tapered thread.

An alternative to drilling into the block is to machine and thread a steel adapter to accommodate the sensor on one end, and a stub with the thread to match those in an existing pre-tapped boss in your block. As noted in the previous sections, it may be necessary to change the sensor location if it is impossible to isolate engine noise while still allowing the ECU to identify knocking.

MAGNET SEEN / NOT SEEN & Aligning the Hall Sensor



Top line is used for checking trigger magnets.
Bottom line is used for checking the sync magnet.

MAGF.JPG

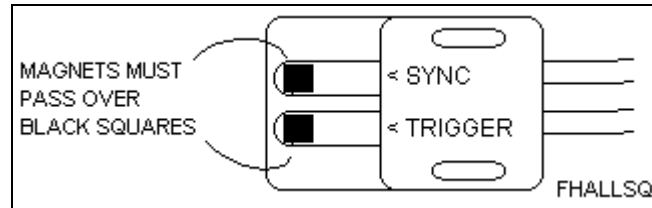

Important! Disconnect the red power wire to the coil pack to disable the spark while rotating the crankshaft.

From gauge1 mode push the '>' button 3 times. The LCD Screen will read MAGNET SEEN or MAGNET NOT SEEN. As a magnet passes the Hall sensor, the graphic will change from NOT SEEN to SEEN.

Rotate the pulley so a magnet is over the sensor. Loosen the Hall sensor mounting bolts and reposition the sensor until the SEEN graphic is displayed with the magnet lined up. Tighten the sensor bolts. Recheck by turning the crankshaft by hand, As each magnet passes the sensor, the display should change to SEEN momentarily. **Each magnet should be SEEN for at least 2 to 3 degrees of crank rotation.**

This window has no use once the engine is running, since the sampling rate of the programmer is only about twice per second.

Make sure that there is at least 1mm clearance (2mm on rubber damped pulleys) between the magnets and the Hall sensor before starting the engine.

MAGNET POSITION



Initial Setup - VERY IMPORTANT

This step requires a timing light. The best timing light to use, is one that does not have a delay knob. Delay lights may not work properly with multi-spark ignitions or with multi-coil/waste spark ignitions. If you only have a delay type light set the delay to 0. The crank pulley and timing cover must have timing marks on them. The timing light inductive pickup clamp can also be connected onto the ground wire of the coil pack unit if clipping to the spark plug wires does not work well. For engines with 1 coil/cyl, the inductive pickup clamp can be connected onto cyl #1 minus terminal wire which is the wire that connects to the blue SDS coil driver box's 1-4 wire.

This involves calling up the MAGNET POSITION parameter using the programmer. **This step should be performed as soon as the engine is fired up and idling. Ignition timing is meaningless without first setting the MAGNET POSITION parameter properly.**

A value of between 70 and 90 entered should allow the engine to be started. 80 would be a good starting point and is where the system is factory set.

STEP 1. Using the Programmer set the following parameters:

RPM IGNITION 500 to a value of 10.

RPM IGNITION 750 to a value of 10.

RPM IGNITION 1000 to a value of 10.

RPM IGNITION 1250 to a value of 10.

RPM IGNITION 1500 to a value of 10.

STEP 2. Make sure that all IGN RET-ADV/LOAD values below boost are 0.

STEP 3. Start the engine and keep it running below 1500 rpm.

STEP 4. Connect a timing light.

STEP 5. Change the MAGNET POSITION value until the timing light reads 10 degrees BTDC.

Once the MAGNET POSITION is set, it does not have to be changed again- it is only to tell the ECU what the "distance" between the #1 MAGNET and Hall sensor is. Once the above 5 steps are completed, you can program any of the ignition values.

MAGNET POSITION may need to be adjusted if the Hall sensor is removed for engine repairs, so after it is installed again, then the above procedure should be completed, so the ignition timing is the same as before.

Ignition Programming

Ignition timing requirements differ widely between various types of engines so we can only offer general guidelines for ignition values. Optimal timing is best found on a dyno or by driving the car. If you have no idea what your ignition curve should look like, programming should be done by somebody who does. **SERIOUS ENGINE DAMAGE CAN OCCUR with improper values entered.** Excessively retarded timing can cause high exhaust gas temperatures while advanced timing can lead to pre-ignition and detonation. **Default values may not be correct for your engine!**

RPM IGNITION



RPMIGN.JPG

This is where the main ignition programming of the system is done. For example, if you want timing at 20 degrees BTDC at 2500 RPM go to RPM IGNITION 2500 and enter 20.

Most engines want total timing between 5 and 15 degrees BTDC at idle- As RPM is increased, total timing is usually slowly increased from 1500 RPM up to 2500 to 4000 RPM- where full advance is usually in - most engines like 30 to 40 degrees total timing here. Often this figure is maintained right up to redline.

Here is a typical RPM only timing curve along the lines above. This will work fine on most engines if you are unsure of what values to enter.

| RPM | TIMING |
|------|--------|
| 1000 | 10 |
| 1250 | 10 |
| 1500 | 13 |
| 1750 | 16 |
| 2000 | 19 |
| 2250 | 22 |
| 2500 | 25 |
| 2750 | 28 |
| 3000 | 30 |
| 3250 | 30 |
| 3500 | 30 |
| 3750 | 30 |
| 4000 | 30 |
| ETC. | |

For most engines running adequate octane fuel, a simple timing curve using only RPM offsets often gives excellent results. For RPM only ignition mapping, enter 0's in all the IGN RET-ADV/LOAD parameter slots.

IGN RET-ADV/LOAD



IGNRA.JPG

This parameter allows programming of 64 points of ignition retard and advance with reference to load on the engine. Load information is from the MAP sensor. On systems not using a MAP sensor, the throttle position sensor is used for load information. RET refers to retard, and ADV refers to advance.

On systems using 1 bar MAP sensors all the IGN RET-ADV/LOAD values are set to zero from the factory. Systems with 2 or 3 bar MAP sensors have some retard programmed in higher boost ranges.

Adding retard in high ranges of IGN RET-ADV/LOAD will help prevent detonation on turbo or high compression normally aspirated engines using street gas. Push the +10 or +1 buttons to increase the amount of ignition retard. If too much retard is programmed, power output from the engine will be

reduced significantly, and detonation may still occur. Total ignition timing should not be less than 15 degrees, since this could shorten the life of some engine components. In turbo applications the engine is more efficient running lower boost pressure with more ignition timing.

Advance is useful to improve fuel economy and lower emissions under part throttle conditions, which is usually from -18" to -9" vacuum. Advance can be programmed by pushing the -1 and -10 buttons on the programmer.

To program ignition timing, two parameters RPM IGN and IGN RET-ADV/LOAD are used. Total timing is a result of the RPM IGNITION value minus any RETARD or plus any ADVANCE.

Below are some example values for timing. Some advance is used under vacuum to help fuel economy, and some retard is used on boost to help prevent detonation. The total timing column does not show all possible results. For instance the engine could be running at 4000 RPM with 15 PSI boost, so in this case the total timing would be 29-15=14 degrees.

| RPM IGN | VAL | IGN RET-ADV/LOAD | | TOTAL TIMING |
|---------|-----|------------------|--------|--------------|
| 500 | 10 | -26.70 | 0 RET | 10 |
| 750 | 10 | -25.80 | 0 RET | 10 |
| 1000 | 11 | -24.90 | 0 RET | 11 |
| 2250 | 29 | -20.40 | 0 RET | 29 |
| 3000 | 29 | -17.70 | 2 ADV | 31 |
| 3500 | 29 | -15.90 | 3 ADV | 32 |
| 3750 | 29 | -15.00 | 5 ADV | 34 |
| 4000 | 29 | -14.10 | 7 ADV | 36 |
| 4250 | 29 | 5.34 | 3 RET | 26 |
| 4500 | 30 | 5.78 | 5 RET | 25 |
| 4750 | 31 | 6.22 | 8 RET | 23 |
| 5000 | 32 | 6.66 | 10 RET | 22 |
| 5250 | 32 | 7.10 | 12 RET | 20 |
| 5500 | 34 | 10.20 | 13 RET | 21 |
| 5750 | 35 | 15.00 | 15 RET | 20 |

Values for IGN RET-ADV/LOAD are limited to a maximum 25 degrees advance, and a maximum 25 degrees retard.

There are hundreds of possible timing curves available with SDS to suit any engine, the previous examples are only hypothetical as mentioned before, efficient timing curves are best developed on the dyno.

Gauge 2 Mode IGN display

You can watch the ignition timing in gauge 2 mode while the engine is running.

A negative sign indicates that the ignition timing is before TDC. Ignition is normally BTDC.

 IGNBTDC.JPG

A positive sign before the ignition degrees number indicates that the ignition timing is after TDC.

 IGNATDC.JPG

If timing is after TDC, then too much retard has been programmed into the system. Having ignition timing after TDC will cause major loss off power and possible engine damage.

The degree symbol changes to the letter K which indicates that knock has been detected, or KNOCK sense value may be set too high.

 IGNK.JPG

Knock Sensing Programming

If you do not have the knock sensor option, set KNOCK RETARD to 0.

The knock sensing option allows you to adjust the sensitivity and selectivity of the EM-4 to hear knock from the sensor and adjust the amount of ignition retard per knock. The knock sensing option can take the place of large amounts of MAP retard in some cases however, total reliance on the sensor while running unrealistically high amounts of spark timing may lead to running problems. **We recommend using the knock sensor as a safety device rather than a primary timing control.**

The knock sensing in the EM-4 will retard the timing a maximum of 15 degrees. If engine knock continues then the engine has either too much turbo boost with too low octane fuel, or too much ignition timing programmed.

Proper location of the sensor and tuning of the KNOCK SENSE along with a proper KNOCK RETARD value are essential for satisfactory operation of this option. Knock control is not a magic bullet. **If the compression ratio or boost pressure is too high for the fuel octane you are using, either knock will occur or you will lose power by having to retard timing to prevent it. Constant hard knocking (detonation) will eventually destroy any engine, sometimes within seconds.**

KNOCK SENSE



KSENSE.JPG

This value is used to adjust the sensitivity of the knock sensor circuit. This is adjustable between 1 and 32, with 1 being least sensitive.

SDS supplied GM sensors mounted near the top of the engine block will need a KNOCK SENSE value of between 2 and 20.

Japanese and German sensors will need a KNOCK SENSE value of between 20 and 32.

Engine knock is most likely to occur around torque peak of the engine, which is usually from 3000 to 5000 on most engines, so sensitivity should be adjusted while in this rpm range.

Adjusting:

The knock sensor may also sense mechanical noise in the engine, so you will need to adjust the KNOCK SENSE carefully.

One method to adjust KNOCK SENSE is to start out with a high value, then rev the engine without any load, and watch IGN reading in gauge2 mode. If the degree symbol changes to show the letter K, then lower the KNOCK SENSE value. Keep lowering KNOCK SENSE and rev the engine until knock is not detected.

If KNOCK SENSE is too high then this may severely retard the timing when in fact no detonation is present. False triggering is more common at higher RPM's. You can use KNOCK MAX RPM to help this problem

KNOCK MAX RPM



KNMAX.JPG

This disables the knock sensor above the RPM setting. This will prevent knock retard from occurring at higher RPM's, typically above 6000 rpm on most engines, since at very high RPM's, there may be a lot of engine noise picked up by the knock sensor.

KNOCK RETARD



KNRET.JPG

This value tells the EM-4 how much to retard the timing when a single knock event is sensed. A value of between 2 and 5 is recommended here.

Under normal engine running with no engine knock, there will be zero retard from the knock feature. When a knock event is sensed, the EM-4 subtracts the KNOCK RETARD amount from the total ignition timing.

Example:

Gauge2 mode shows IGN 30°.

KNOCK RETARD is 5.

If a knock event occurs, Gauge2 mode would show IGN 25K. (30-5). K indicates that a knock event occurred.

Usually when knock occurs there will be more than one knock event sensed, so the EM-4 will add up the multiple knock events. If you had for example, a 4 entered for KNOCK RETARD, then if 2 events were sensed, the EM-4 will have 8 degrees of knock ignition retard. If knock has stopped, then the EM-4 will slowly reduce the amount of knock ignition retard at a rate of approximately 2 degrees per second until zero.

Testing the knock sensor

The engine does not need to be running.

Set KNOCK MAX RPM to 1000 or higher.

Set KNOCK SENSE to 10 for GM sensor, 30 for Japanese and German sensors.

Set KNOCK RETARD value to 3 or higher.

Display gauge2 mode in the programmer. Push the gauge button then > button.

Tap on the knock sensor lightly with a 10mm wrench.

You should see the IGN in gauge2 mode change and the letter K will appear after the 2 digits.

If the knock sensor is a 2 terminal style and is not working, try reversing the 2 wires to fix the problem. On some sensors you can identify which terminal is ground by checking for continuity from the terminals to the metal sensor housing.

PIN 13 INPUT

PIN 13 INPUT
A/C

PIN 13 INPUT
NITROUS

PIN 13 INPUT
LAUNCH REV LIMIT

This allows you to select the function of the pin13 green 20 ga wire on the main harness for 3 different functions. This feature is available only on "E" or "F" models, not "D"(fuel only models).

1. A/C.
2. Nitrous. (ignition retard)
3. Launch Rev Limiting.

Use the +1 or -1 buttons to change the selection.

A/C setting allows the computer to turn on the radiator fan relay and fast idle relay whenever 12 volts is seen on the green pin 13 wire. The green wire will need to be connected to the A/C clutch positive wire.

Nitrous setting will retard ignition by the amount programmed in the NITROUS RETARD parameter. Press the < button on the programmer to get to the Nitrous Retard parameter.

Launch Rev limiting retards timing and limits engine rpms only at high throttle when this input sees +12 volts.

A/C FAST IDLE or NITROUS RETARD

Depending on which PIN 13 function is selected(see above), the parameter in this position will appear as either of these:

A/C FAST IDLE
YES

NITROUS RETARD
8°

LAUNCH REV LIMIT
4750 25° RET

A/C Fast Idle: If PIN13 INPUT is set for A/C then you can select whether A/C input activates the fast idle valve. Yes means fast idle turns on with A/C. No means fast idle stays off with A/C. Yes/no selection is made by pressing the +1 or -1 buttons.

Nitrous Retard: this is the amount of retard that will be added to the ignition timing when pin 13 green wire sees +12 volts only if throttle position is 40 or higher.

Nitrous retard response time specifications in Seconds:
Turn on .0005. Turn off .25

Turn off of nitrous retard is controlled by a software delay, and this allows nitrous retard to continue until residual nitrous in the intake plumbing has been consumed by the engine. See below for hookup.

Launch Rev Limit allows adjustment of a lower rev limit, and also allow adjustment of ignition retard. Pressing the +1 and -1 buttons will change the timing retard by 5 degree steps, until you hit a maximum of 35, or a minimum of 0, and then the RPM setting will change by 250 rpms.

Important notes: Launch rev limit cuts the spark only, but fuel still gets injected.

There must be +12 volts at the pin13 green wire input to activate this rev limit. This is intended for race vehicles without mufflers, mainly for drag racing. This feature could also be used to cut engine power for sequential shift gearboxes.

A setting can be changed in setup mode so that this rev limit is only active above throttle position 40. Contact us by phone or email if you need this setting changed.

Hookup: Activation can be done by wiring a 12 volt source through a clutch switch or hand activated switch connected to the pin13 green 20 gauge wire. SDS does not provide a switch with systems.

Nitrous ignition retard hookup

Diagrams below show pin13 green wire must be connected at the output of the arm/disarm switch. When the arm/disarm switch is turned off, then no nitrous retard will occur.

Important! Two things must occur for nitrous retard to function:

1. Pin13 green wire must see +12 volts.
2. Throttle position must be 40 or higher. Check gauge3 mode to see if your throttle goes high enough.

If you have a problem where your throttle position does not go up to 40, it is often possible to loosen the TPS mounting bolts and rotate the TPS, since many TPS's have slotted holes.

If you want nitrous retard all the time, or have no arm/disarm switch, then you should permanently connect the pin13 green wire to +12 volts.

If you are not using the nitrous retard feature, then you should leave the pin13 green wire unconnected, and also leave the PIN13 INPUT setting in the programmer set as A/C.

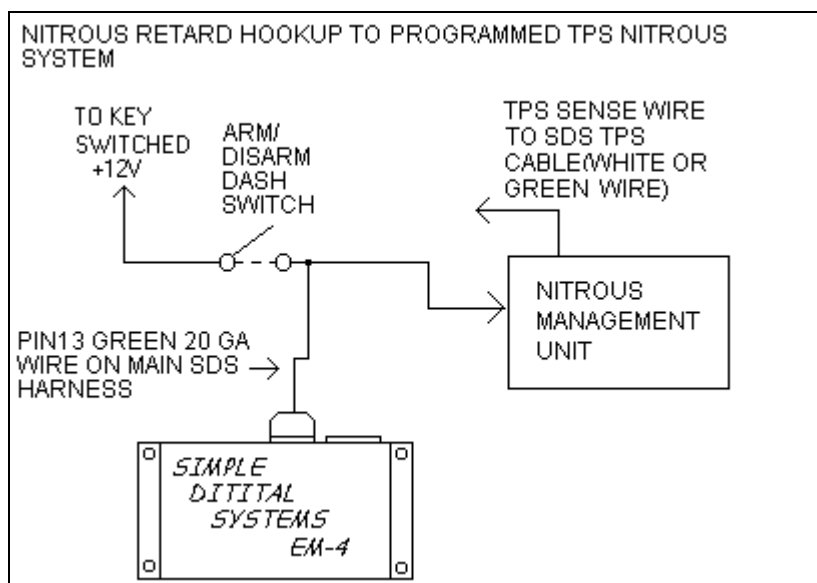
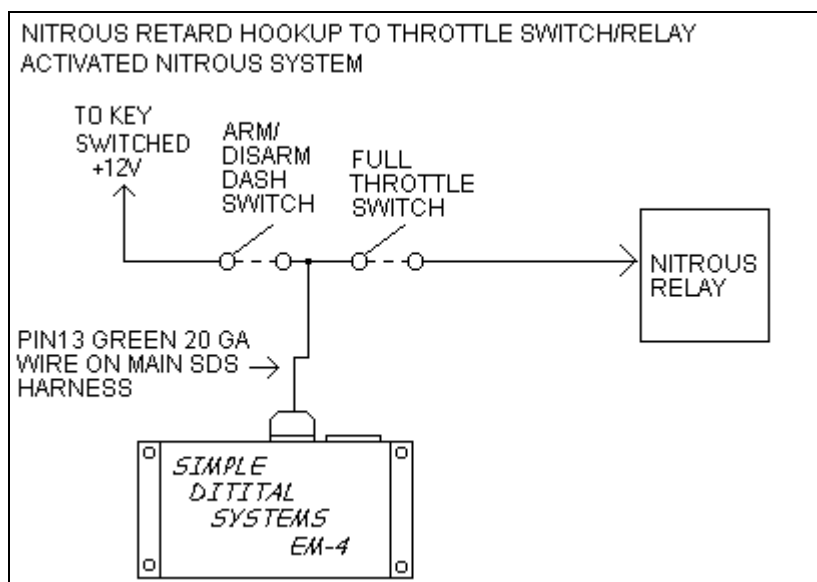

Testing the coil pack for spark. Caution high voltage!

Never test for spark by just removing the plug wires.

Clamp spare spark plugs together and plug in ignition wires to the coil under test. If you don't have spare spark plugs use some steel lock wire and wrap it around 1 coil terminal and run it over to the other terminal leaving a small gap to be able to see the spark jump.

Connect the black wire to ground and the red wire to +12 volts.

Touch +12v momentarily to the input marked A on the black connector. There should be a spark from the #1 coil. Move the spark plug wires to the other coil and momentarily apply +12 volts to the input marked B on the black connector. There should be a spark from this coil.

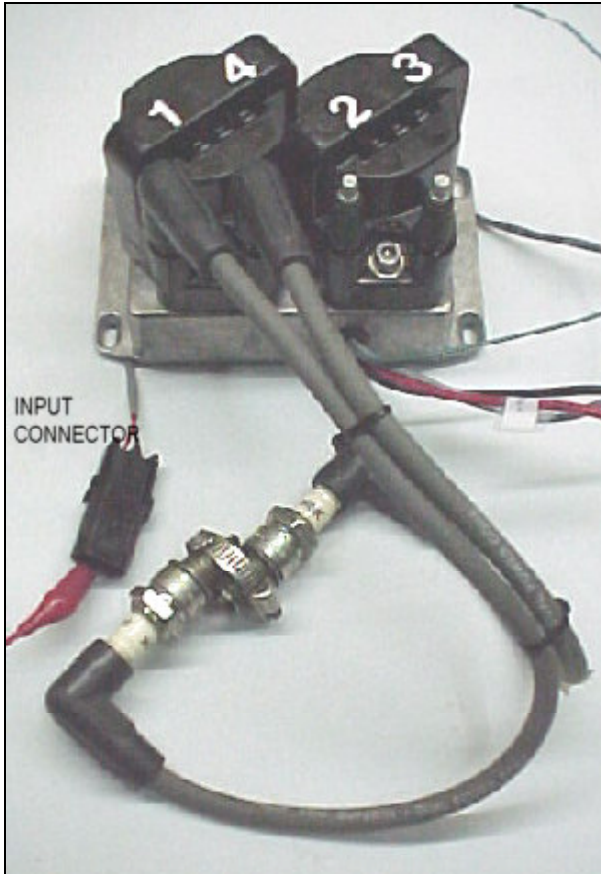

FCOILTEST.JPG

Note: Coil packs when triggered manually, will only produce one spark approximately every 5 seconds, due to fault/safety circuitry that limits coil charge time and protects the coil pack unit from damage.

Troubleshooting

Spark plugs

We recommend resistor type spark plugs only. Non resistor type may cause electrical interference.

Spark plug wires, and Interference Problems

Always use radio suppression type spark plug wires. NEVER use solid core wires.

Recommended wires:

Magnecor, MSD superconductor, NGK, OEM or factory carbon string, Accel 8.8 yellow.

Important! Wires which have caused interference problems in the past are Nology, Mallory and Taylor, so we do not recommend these. If you have these wires and are having problems try a different brand of wires. Ignition interference problems usually show up as strange characters in the programmer screen, rough running, misfiring or an RPM ERR code in gauge1 mode.

Will not start:

1. Check power and ground connections. Run power wires direct to battery.
2. Check Hall sensor alignment.
3. Connect timing light and check timing while cranking the engine. Best to unplug injectors to avoid flooding the engine with gas.

Runs but no power:

1. Knock sensor picking up engine noise. Adjust KNOCK SENSE value.
2. If you don't have a knock sensor installed set KNOCK RETARD to zero.
3. Keep knock(yellow) wire away from spark plug wires.
4. Magnets positioned incorrectly, so timing is retarded too much. Check timing with a timing light (non-knob or non-delay type).
5. RPM IGNITION values are too low.

RPM ERR message or engine miss:

1. Check Hall sensor alignment.
2. Check Hall sensor air gap.
3. Hall sensor bracket is vibrating. Improve bracket.
4. Interference from plug wires. Try a different brand of spark plug wires.
5. Make sure that all SDS sensor wiring and Hall sensor cable is not close to spark plug wires or any high current/voltage wires.
6. Check plug gap. Reduce to confirm.
7. Check alignment of Hall sensor over magnets. Loosen Hall sensor mounting bolts and try adjusting Hall sensor.
8. Spark plug gap too high. Reduce gap.

Knock sensor not working:

1. Set KNOCK SENSE to the highest value.
2. Set KNOCK MAX RPM to 9000.
3. Test by hitting the sensor with a small wrench.
4. On two wire sensors try reversing the wires.
5. Single wire knock sensors need chassis ground so make sure they make metal to metal contact.

Coil pack fuse blows all the time:

1. Hall sensor and magnets not aligned.

I only received one magnet:

1. The magnets stick together really well. Separate them with your fingers.